

Serial No.	H-V005-E-4
------------	------------

Lab Cock

User's Manual

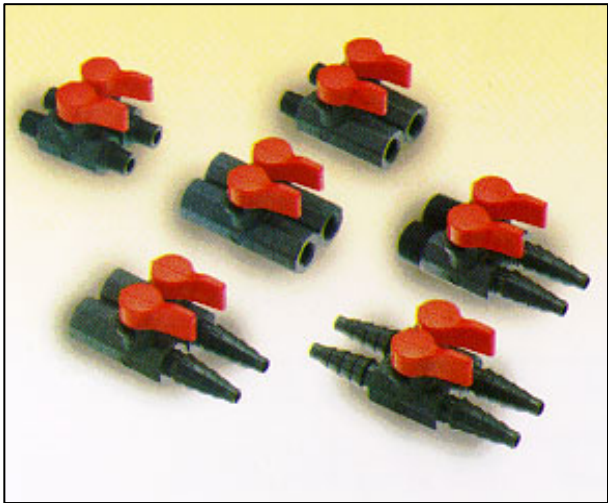



Contents



- (1) Be sure to read the following warranty clauses of our product 1
- (2) General operating instructions 2
- (3) General instructions for transportation, unpacking and storage 2
- (4) Name of parts 3
- (5) Working pressure vs. temperature 4
- (6) Installation procedure 5
- (7) Operating procedure 6
- (8) Inspection items 6
- (9) Troubleshooting 6
- (10) Handling of residual and waste materials 6

This user's guide contains information important to the proper installation, maintenance and safe use of an ASAH I AV Product. Please store this manual in an easily accessible location.

<Warning & Caution Signs>

 Warning	This symbol reminds the user to take caution due to the potential for serious injury or death.
 Caution	This symbol reminds the user to take caution due to the potential for damage to the valve if used in such a manner.







<Prohibited & Mandatory Action Signs>

	Prohibited: When operating the valve, this symbol indicates an action that should not be taken.
	Mandatory action: When operating the valve, this symbol indicates mandatory actions that must be adhered to.





(1) Be sure to read the following warranty clauses of our product

- Always observe the specifications of and the precautions and instructions on using our product.
- We always strive to improve product quality and reliability, but cannot guarantee perfection. Therefore, should you intend to use this product with any equipment or machinery that may pose the risk of serious or even fatal injury, or property damage, ensure an appropriate safety design or take other measures with sufficient consideration given to possible problems. We shall assume no responsibility for any inconvenience stemming from any action on your part without our written consent in the form of specifications or other documented approval.
- The related technical documents, operation manuals, and other documentation prescribe precautions on selecting, constructing, installing, operating, maintaining, and servicing our products. For details, consult with our nearest distributor or agent.
- Our product warranty extends for one and a half years after the product is shipped from our factory or one year after the product is installed, whichever comes first. Any product abnormality that occurs during the warranty period or which is reported to us will be investigated immediately to identify its cause. Should our product be deemed defective, we shall assume the responsibility to repair or replace it free of charge.
- Any repair or replacement needed after the warranty period ends shall be charged to the customer.
- The warranty does not cover the following cases:
 - (1) Using our product under any condition not covered by our defined scope of warranty.
 - (2) Failure to observe our defined precautions or instructions regarding the construction, installation, handling, maintenance, or servicing of our product.
 - (3) Any inconvenience caused by any product other than ours.
 - (4) Remodeling or otherwise modifying our product by anyone other than us.
 - (5) Using any part of our product for anything other than the intended use of the product.
 - (6) Any abnormality that occurs due to a natural disaster, accident, or other incident not stemming from something inside our product.

(2) General operating instructions

-   - Using a positive-pressure gas with our plastic piping may pose a dangerous condition due to the repellent force particular to compressible fluids even when the gas is under similar pressures used for liquids. Therefore, be sure to take the necessary safety precautions such as covering the piping with protective material. For inquiries, please contact us. For conducting a leak test on newly installed piping, be sure to check for leaks under water pressure. If absolutely necessary to use a gas in testing, please consult your nearest service station beforehand.
-   - Do not step on or apply excessive weight on valve. (It can be damaged.)
-  - Do not use the valve in conditions where the fluid may have crystallized. (The valve will not operate properly.)
-  - Keep the valve away from excessive heat or fire. (It can be damaged, or destroyed.)
- Always operate the valve within the pressure vs. temperature range. (The valve can be damaged or deformed by operating beyond the allowable range.)
- Allow sufficient space for maintenance and inspection.
- Keep the valve out of direct sunlight, water and dust. Use cover to shield the valve. (The valve will not operate properly.)
- Perform periodic maintenance. (Leakage may develop due to temperature changes or periods of prolonged storage, rest, or operation.)

(3) General instructions for transportation, unpacking and storage

-   - This valve is not designed to handle impacts of any kind. Avoid throwing or dropping the valve.
-  - Avoid scratching the valve with any sharp object.
- Do not over-stack cardboard shipping boxes. Excessively stacked packages may collapse.
- Avoid contact with any coal tar creosote, insecticides, vermicides or paint. (These chemicals may cause damage to the valve.)
-  - Store products in their corrugated cardboard boxes. Avoid exposing products to direct sunlight, and store them indoors (at room temperature). Also avoid storing products in areas with excessive temperatures. (Corrugated cardboard packages become weaker as they become wet with water or other liquid. Take care in storage and handling.)
- After unpacking the products, check that they are defect-free and meet the specifications.

(4) Name of parts

■ Female thread x female thread type

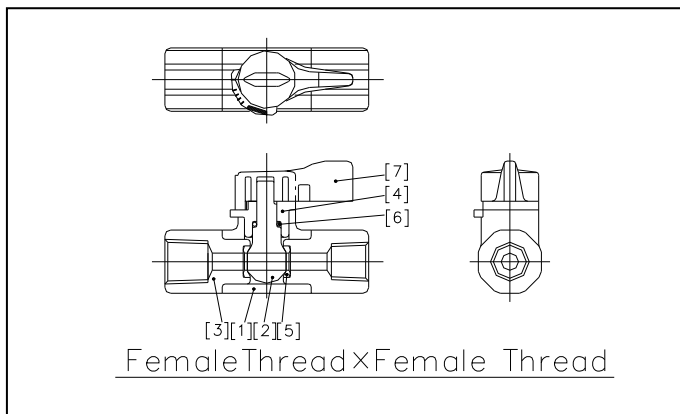

No.	DESCRIPTION
[1]	Body
[2]	Ball & Stem
[3]	End connector
[4]	Gland
[5]	Seat
[6]	O-ring
[7]	Handle



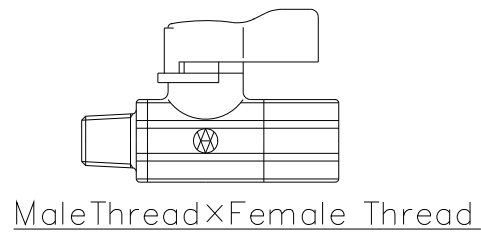
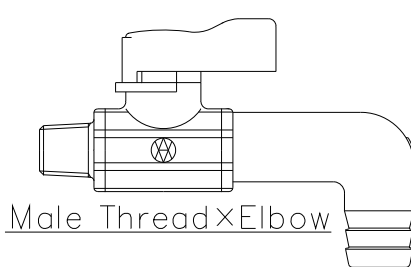
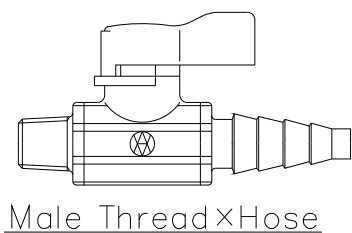
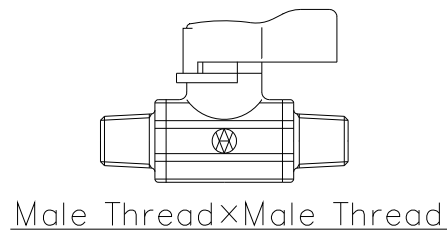
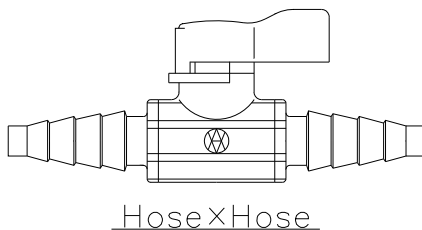
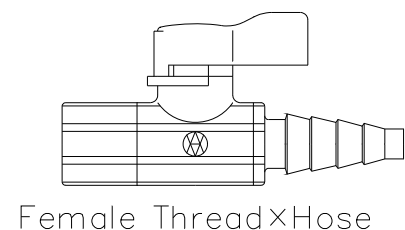

*Any parts can not be exchanged except from the handle.

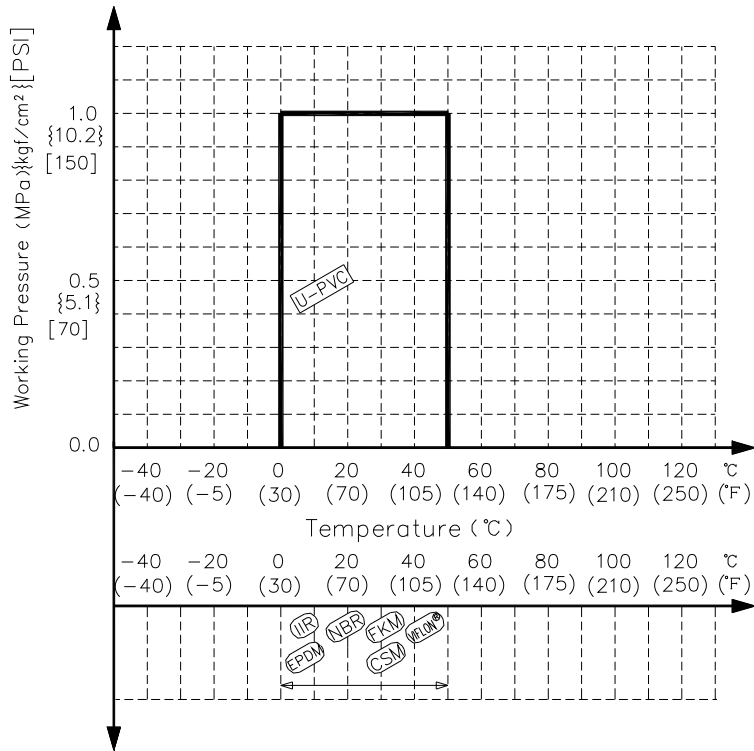

(5) Working pressure vs. temperature



(6) Installation procedure

  - Avoid excessive tightening. (The valve can be damaged.)
 Caution  - Do not use the pipe wrench. (The valve can be damaged.)
 - Make sure that the threaded connections are plastic x plastic. (Metallic thread can. cause damage)
 - Wrap the threaded joints on our plastic piping with sealing tape. Using a liquid sealing agent or liquid gasket may cause stress cracks (Environmental Stress Cracking). Our product warranty shall not apply in case of said use, even when said use is unavoidable.

Lab Cock has 15 kinds of products, with combinations of male thread, female thread and hose, and different sizes. There are explanations about each connector as following;

Male Threaded type

Necessary items

- Sealing tape
- Strap wrench

Procedure

- 1) Wind a sealing tape around the male thread connector, leaving the end (about 3mm) free.
- 2) Tighten it to the female thread of the joint by hand.
- 3) Using a strap wrench, screw in the end connector by turning 180°- 360°carefully without damaging it.

Female Threaded type

Necessary items

- Sealing tape
- Strap wrench

Procedure

- 1) Wind a sealing tape around the male thread of joint, leaving the end (about 3mm) free.
- 2) Tighten the male thread of the joint and the female thread connector lightly by hand.
- 3) Using a strap wrench, screw in the end connector by turning 180°- 360°carefully without damaging it.

Hose type

- Use hoses with the bore size 12-15mm to connect to the valve.
- Push in by hand, not by any tools. The hose may come off when the working pressure rises over the maximum.

(7) Operating procedure

- Open and close the valve by turning handle quietly.



(Turn the handle clockwise to close and counter clockwise to open.)

For the full-closed position, the handle is perpendicular to the piping axis direction.

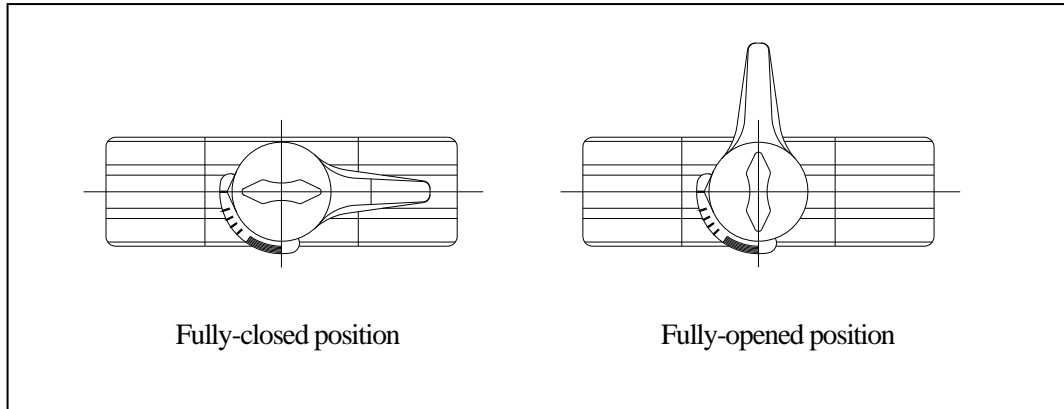
For the full-opened position, the handle is parallel to the piping axis direction.



(8) Inspection items

  - Perform periodic maintenance. (Leakage may develop due to temperature changes or over periods of prolonged storage, rest or operation.)



Inspect the following items;

(1)	Existence of scratches, cracks, deformation, and discoloring.
(2)	Existence of leakage from the valve to the outside.
(3)	Existence of leakage when the valve is opened fully at right or left.

(9) Troubleshooting and action

- The valve can not be disassembled, so replace the valve itself when troubled.

(10) Handling of residual and waste materials

  - Make sure to consult a waste treatment dealer for recommendations on the proper disposal of plastic valves. (Poisonous gas is generated when the valve is burned improperly.)

Lab cock



ASAHI AV VALVES

Distributor

Asahi Organic Chemicals Industry's homepage

<http://www.asahi-yukizai.co.jp/en/>

Information in this manual is subject to change without notice.

2011.5